

Rack In The Cases Ltd

AD:Room 2802,Building A,World Trade plaza,No.8,Fuhong Road,
Futian District,Shenzhen China

Web: www.raykglobal.com

Tel: +86 755-82500272

Fax:+86 755-25322790

RK Stage,Bring You A Colorful Life!

>>>Company profile



Rack in the Cases Limited(RK) is the wholly-owned subsidiary of BlueGiant Group. It runs a professional flight case, stage system and truss facilities in manufacturing and marketing. Currently, RK have three manufacturings bases in Taishan, Dongguan, Foshan respectively with more than 1000 employees. With 14 years of experience in audio & staging business, as well as continuously creative new production, RK's products have been up to the international standards. Its China sales headquarter locates in 2802 WorldTradePlaza, Futian District, Shenzhen, China.

Line up with the goal "One case, Racking the world", RK supplies high quality service for customers. Take the "brandeffect" as mission, Rk commits to selling his products all over the world.

Explanation of company logo

Primary meaning:

RK=RACK, it reflects the main product of Rack in the Cases Limited. RACK CASE is a major kind of flight case, and also a general term of flight cases. The moral of it, RK is going to be the pioneer of flight case in the world .

Secondary meaning:

R= RIVER, the letter "R" in the logo performances like flowing river. The moral of it, RK will shine more gloriously and have a long history.

Main products: flight case, stage, lighting truss, dance floor, various kinds of bleacher, and so on.

Lead by a manager with decades of design experience, our R&D team is on hand to handle OEM/ODM, We strictly implement the ISO 9001:2008 and get the German TUV Certificate. We adhere to "people-oriented, customer first, continuous innovation", and "professionalism".

Since 2009, we have changed our marketing strategy to looking for RK Sole Agent. currently, we have 7 agents in the world, and the annual sales revenue is above 4.5million US dollars. Since 2011, we are looking for secondary agent in the world.

"One World, One Stage, One RK" commits building world-famous brand as RK's mission, high quality, good service and win-win policy as operation principle.

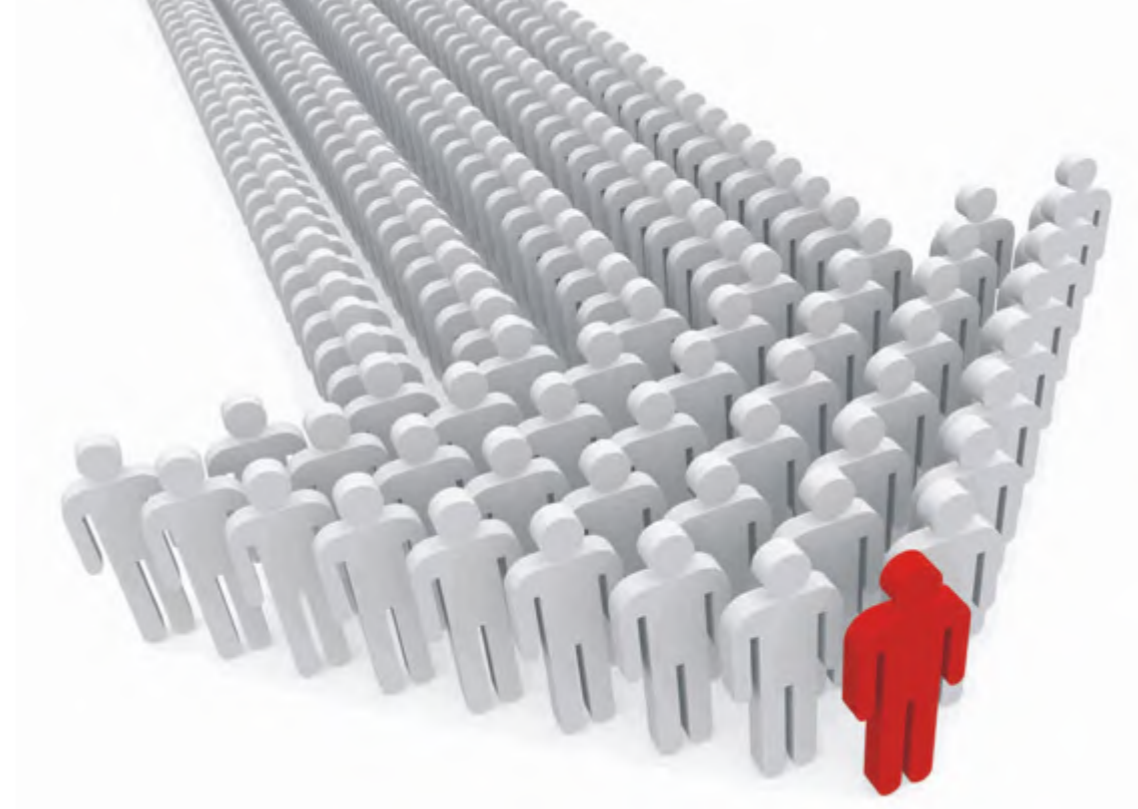

CONTENT

7 Smart Stage

11 Beyond Stage

13 Aluminum Stage

15 Steel Folding Stage

17 Dance Floor

21 Cable Ramp

Smart Stage Platform



Square Shape

Size(US): 3'x3',4'x4'
 (EU): 1m*1m,0.5m*0.5m,0.3m*0.3m
 Plywood Thickness: 18mm or 30mm
 Surface: Carpet,Non-slip Industrial,
 Tuffcoat

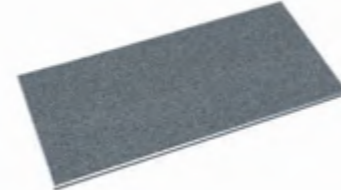

Rectangle Shape

Size(EU): 2m*1m,1m*0.5m
 Plywood Thickness: 18mm or 30mm
 Surface: Carpet,Non-slip Industrial,
 Tuffcoat

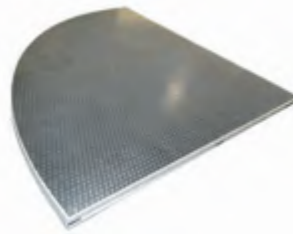

Quarter Round

Size(US): R=3',4'
 (EU): R=1m
 Plywood Thickness: 18mm or 30mm
 Surface: Carpet,Non-slip Industrial,
 Tuffcoat

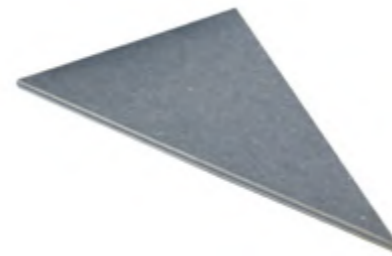

Triangle Shape

Size(US): 3'x3'x3',4'x4'x4'(60°)
 (EU): 1m*1m*1m
 Plywood Thickness: 18mm or 30mm
 Surface: Carpet,Non-slip Industrial,
 Tuffcoat

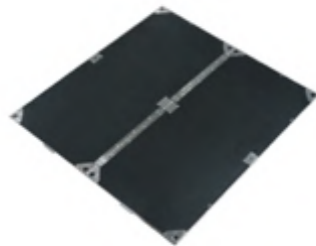

Folding Platform

Size(EU): 1m*1m
 Plywood Thickness: 18mm or 30mm
 Surface: Carpet,Non-slip Industrial,
 Tuffcoat



Stair Platform

Size: 925mm*325mm
 1220mm*325mm
 1000mm*360mm
 Plywood Thickness: 18mm or 30mm
 Surface: Carpet,Non-slip Industrial,
 Tuffcoat



Square Shape Riser

Size(US): 3'x3',4'x4'
 (EU): 1m*1m,0.5m*0.5m,0.3m*0.3m
 Height(US): 8",16",24",32"
 (EU): 20cm,40cm,60cm,80cm,100cmt



Rectangle Shape

Size(EU): 2m*1m,1m*0.5m
 Height (EU): 20cm,40cm,60cm,80cm,100cm



Quarter Round Riser

Size(US): R=3',R=4'
 (EU): R=1m
 Height(US): 8",16",24",32"
 (EU): 20cm,40cm,60cm,80cm,100cm



Triangle Shape

Size(US): 3'x3'x3',4'x4'x4'
 (EU): 1m*1m*1m
 Height(US): 8",16",24",32"
 (EU): 20cm,40cm,60cm,80cm



Step Riser

Size(US): 3',4'
 (EU): 1m
 Height(US): 8",16",24",32"
 (EU): 20cm,40cm,60cm



20cm 40cm 60cm 80cm

Smart Stage Riser

Accessories



Stage Guard Rail



Stair Hand Rail

Specification :

1.Stage Guard Rail:3',4',and 1m width is universal,1m height

2.Stair Handrail:0.36m(W)*1.0m(H)



Skirt

Color: red,black,gray
Height: 10cm-250cm(EU),8"-48"(US)
Width: 2m(EU),4'(US)



Chair Stop

We offer ascending and descending chair stops for our 2m*1m,1m*1m and 1m*0.5m stage platforms as well as our step platforms.



Wheelchair Ramp

Height: 30cm,40cm,50cm,60cm,80cm
Length: 4.4m,5.6m,7m,8.4m,12.4m
The angle of the ramp is 3 degree

Packing



Trolley

Carry 12sets 2m*1m/4'*4'/1m*1m platforms and risers



Riser Storage Case

Riser storage Case for 2m*1m 10pcs riser,1m*1m18pcs,also Customized case is available



Storage Case

Storage road-cases are a convenient way of protecting, storing and transporting all your stage components in one neat, secure package. Holds up to 6 pieces of 2m*1m ,or 1m*1m stage platforms,risers,skirts,steps and all accessories,yet fits through a standard dorrway.



Caster System

Dimension: 1m*1m platforms 36pcs
2m*1m platforms 20pcs



Stage Frame

Size: 1m*1m,2m*1m,3'*3',4'*4'

SMART STAGE SYSTEM



Smart stage

Smart Stage with Wheel Frame

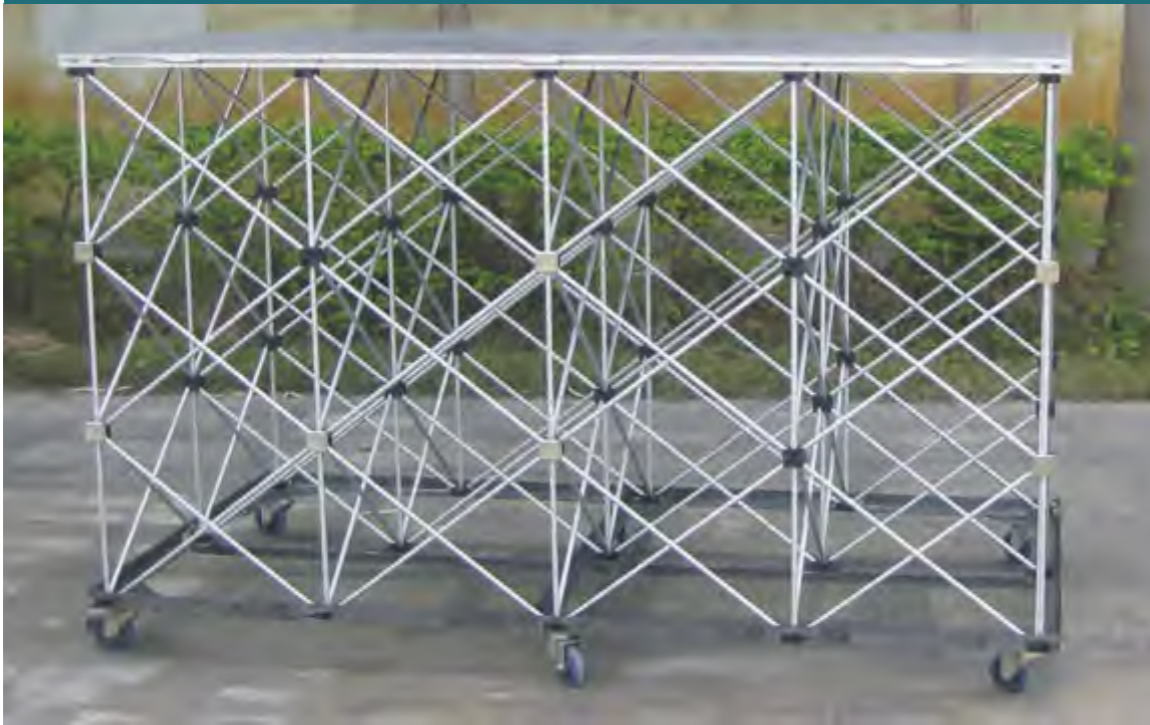

Frosted Plexiglass Stage

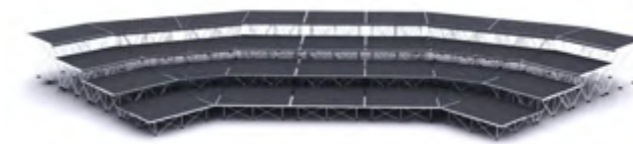

Smart Stage

Choral Stage

Width: 50cm
 Height: 20cm,40cm,60cm
 Surface: carpet,non-slip industrial, tuffcoat
 Applications: concert,theater,auditorium

Seating System

Height: 20cm,40cm,60cm
 Surface: carpet,non-slip industrial, tuffcoat
 Application: concert,theater,auditorium

Magic Stage

Size: 446mm*448mm*523.4mm
 1220mm*610mm*910mm
 1220mm*610mm*758mm
 1174mm*699mm*1226mm
 Application: concert,theater,auditorium

Plexiglass Smart Stage

Size: 1m*1m,4'*4'
 Height: 20cm,40cm,60cm, 80cm,100cm
 Application: concert,theater,catwalk show

Choral Stage Project



Stage Project

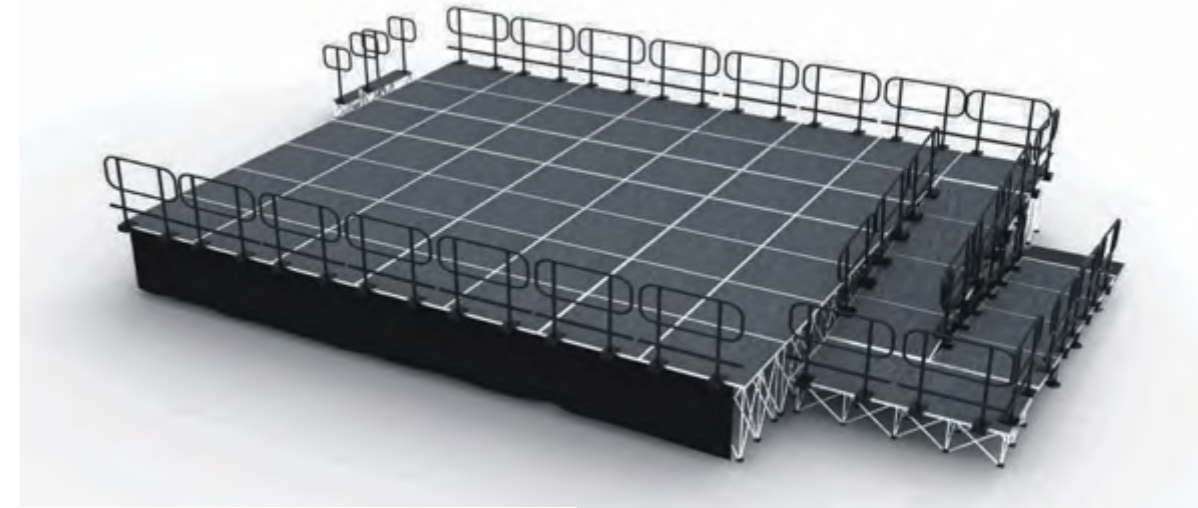

Catwalk Project

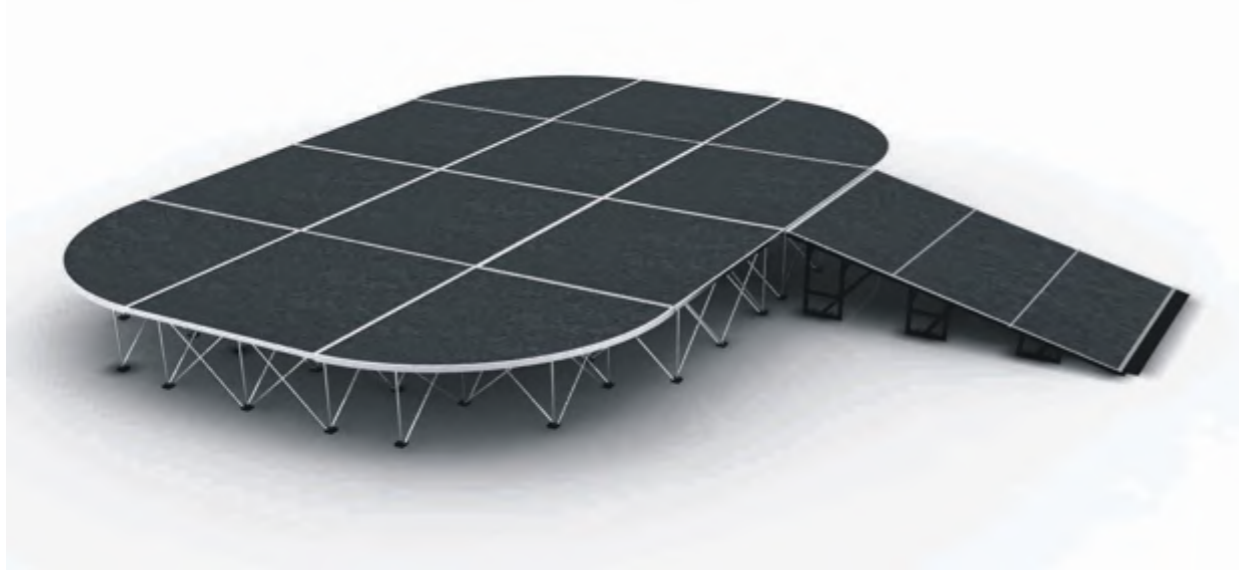

EVENTS



Beyond Stage

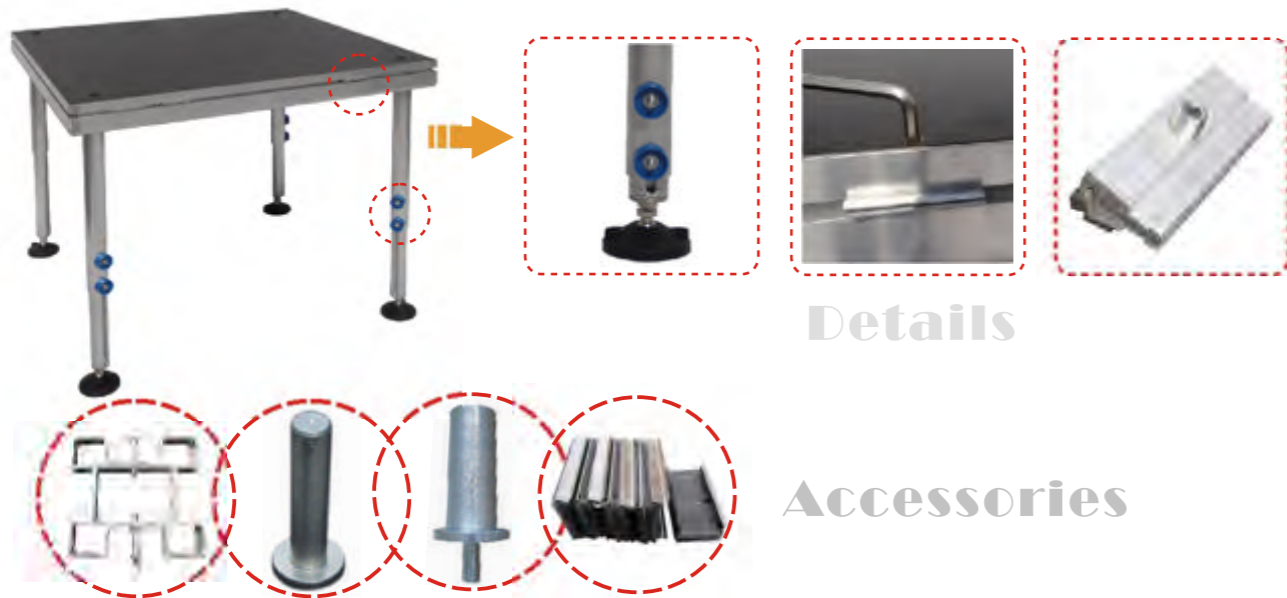

Details

Accessories

Specification

Surface: carpet, non-slip industrial, tuffcoat
Size: 1m*1m, 2m*1m, 1.22m*1.22m, 1.22m*2.44m
Adjustable Height: 0.4-0.6m, 0.6-1.0m, 0.7-1.2m, 0.8-1.4m etc.
Loading Weight: 750kg/m ²

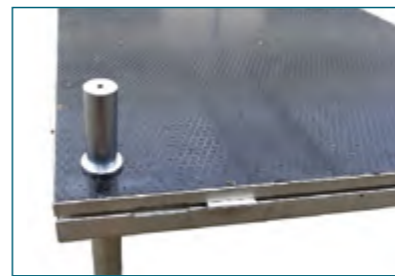

Aluminum Stage

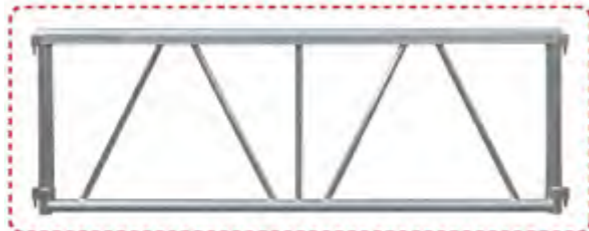
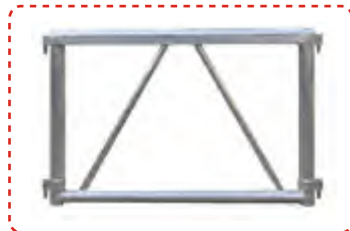
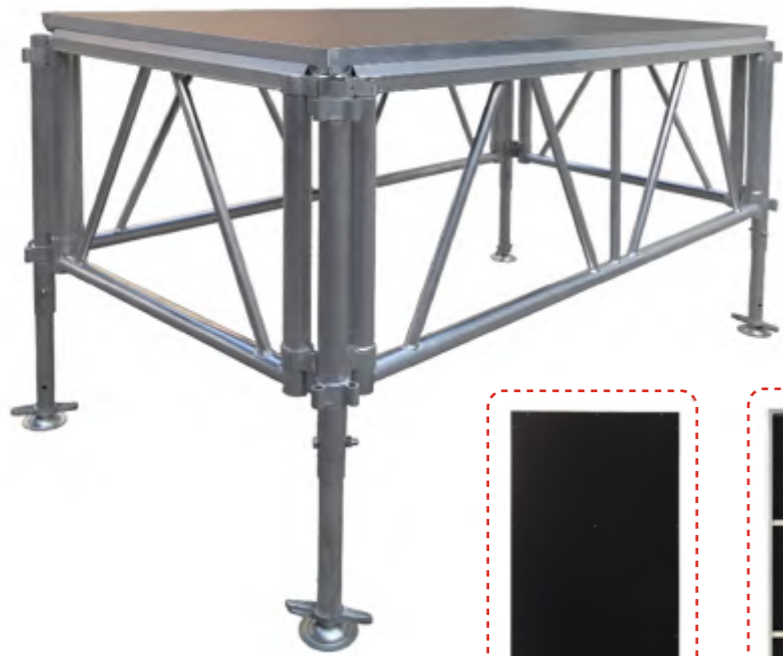

Specification

Surface: carpet, non-slip industrial, tuffcoat

Size: 1m*1m, 2m*1m, 1.22m*1.22m, 1.22m*2.44m

Height: 0.4-0.5-0.6m, 0.6-0.8-1.0m, 0.8-1.0-1.2m, 1.0-1.3-1.5m etc.

Loading Weight: 750kg/m²



Steel Folding Stage



Specification

Dimension: 1220mm*2440mm, 1830mm*2440mm.

Height: 410-610mm, 610-810mm.

Surface: carpet, non-slip industrial, tuffcoat

Max Loading : 800kg/m²

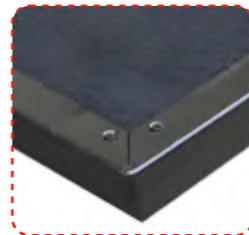

Project 1



Project 2



Project 3

Danceing Floor

Our portable dance floors come with lightweight, heavy duty, easy installation with only one tool hex key or without any tools. They are very popular for banquet hall, hotel, theater, club, school, etc. Whether you are going to host a professional dancing competition or just a back yard barbecue at home, we have a product for you, for any applications or budget. Just speak out your idea, we will provide you a good solution with any applications or budget, let's enjoy a wonderful party time.

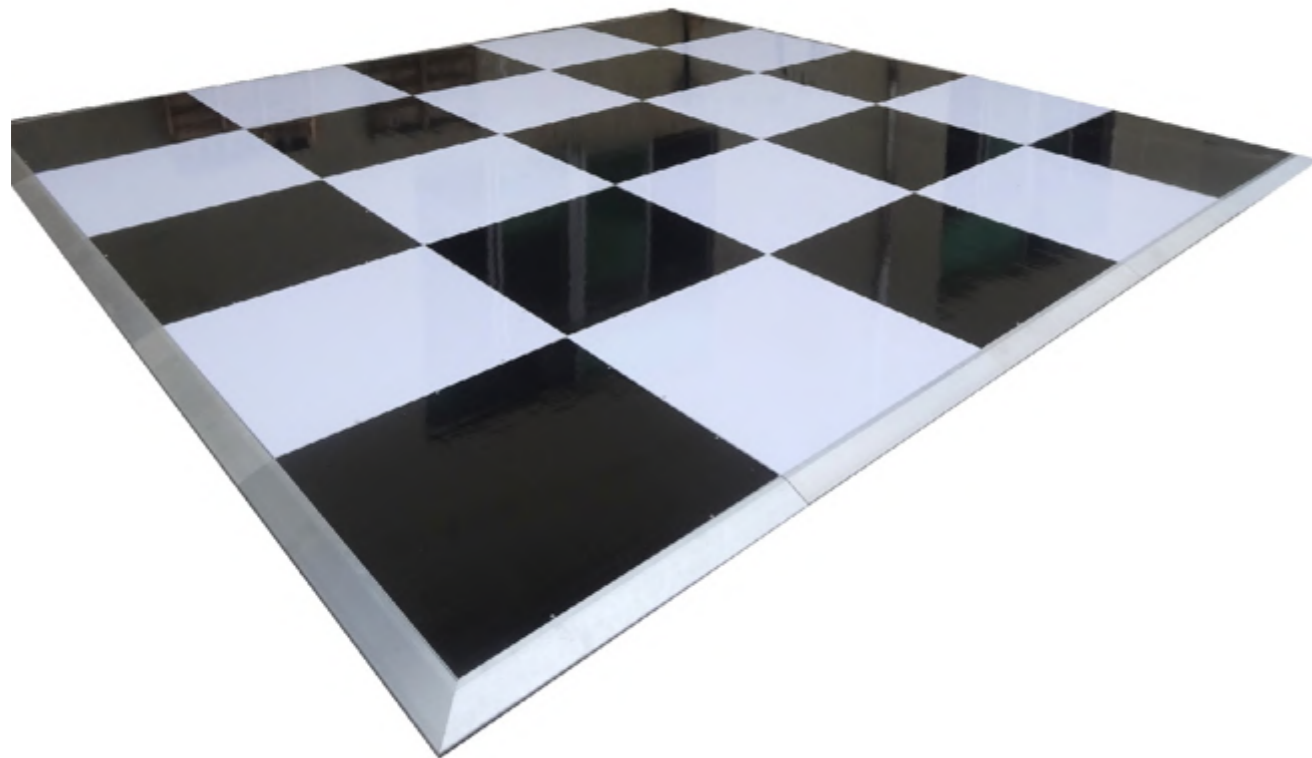

Wooden

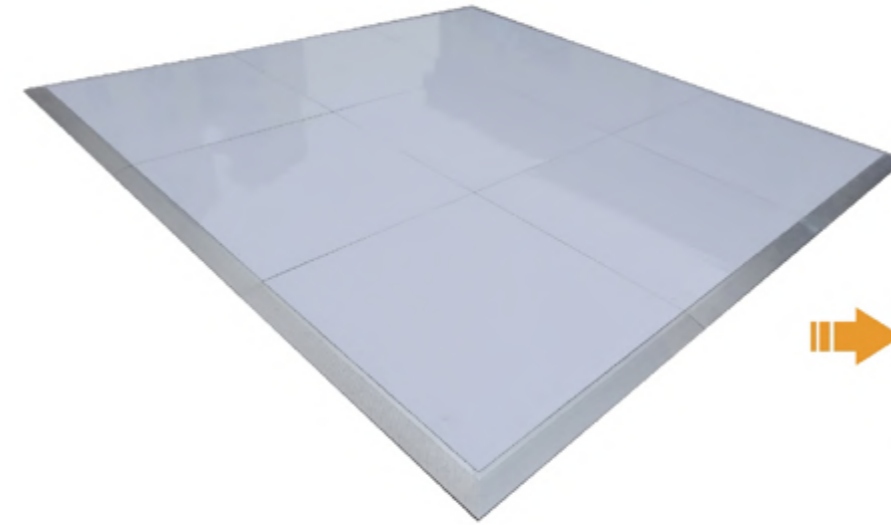

Straight Trim Ending



Bevel Trim Ending

Surface



PVC Dancing Floor

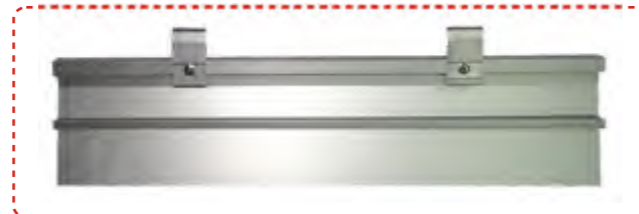
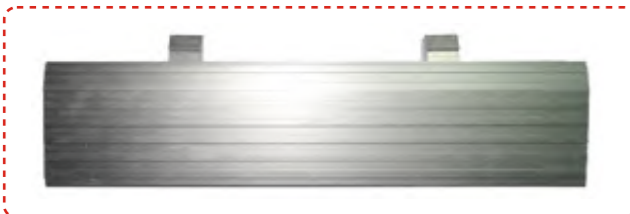

Wooden Look

White

Black

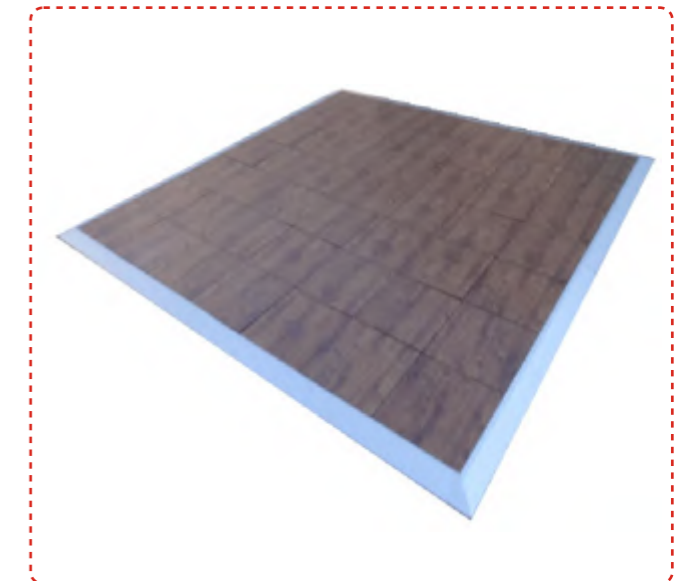

Cable Ramp

Two Channel

Material: rubber
 Size:1000mm * 250mm * 50mm,channel size:30mm*30mm
 Loading Capacity:15-20T



Two Channel Corner



Extra Large Two Channel

Material:EVA cover,rubber base
 Size:900mm *615mm *105mm,channel size:90mm*90mm
 Loading Capacity:15-20T

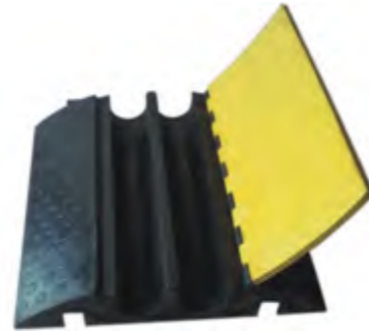

Three Channel

Material: rubber
 Size:1000mm*310mm*55mm,channel size:35mm*35mm
 Loading Capacity:15-20T



Extra Large Three Channel

Material:EVA cover,rubber base
 Size:900mm*600mm*75mm,channel size:60mm*50mm
 Loading Capacity:15-20T



Four Channel

Material: rubber
 Size:800mm*400mm*55mm,channel size:40mm*40mm
 Loading Capacity:15-20T



Five Channel

Material: rubber
 Size:770mm*485mm*65mm,4 channel 40mm*40mm+1 channel 42mm*18mm
 Loading Capacity:15-20T



Extra Large Five Channel

Material:EVA cover,rubber base
 Size:900mm*600mm*75mm,channel size:50mm*40mm
 Loading Capacity:15-20T



Five Channel Corner

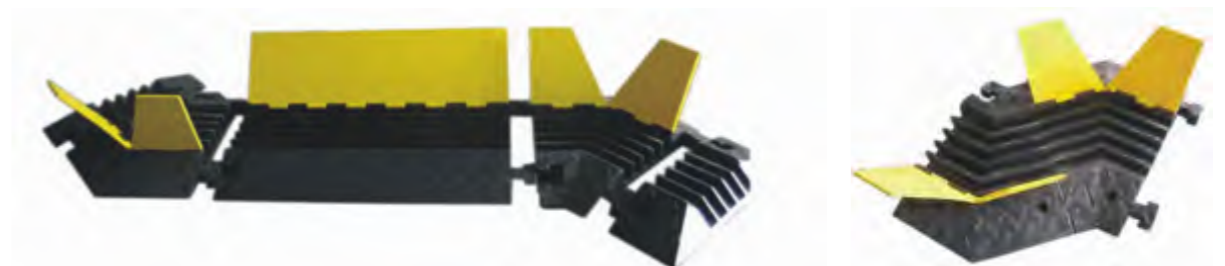

Truss System with Staging

